









No. porte.:	commande:	nombre:
-------------	-----------	---------

- Type de porte:
- |                          |                               |                          |                                       |
|--------------------------|-------------------------------|--------------------------|---------------------------------------|
| <input type="checkbox"/> | porte de clôture de palissade | <input type="checkbox"/> | porte à cadre en bois/porte de levage |
| <input type="checkbox"/> | porte de clôture à lattes     | <input type="checkbox"/> | porte de clôture de pré               |
| <input type="checkbox"/> | en mélèze d'Europe            | <input type="checkbox"/> | porte de paroi pare-vue               |
| <input type="checkbox"/> | porte avec acier en U         | <input type="checkbox"/> | porte sur modèle                      |
| <input type="checkbox"/> | porte de clôture treillis     |                          |                                       |

- Forme de la tête:
- |                          |                                                                                   |                          |                                                                                   |                          |                                                                                   |                          |                                                                                   |                          |                                                                                     |                          |                                                                                     |                          |                                                                                     |                          |                                                                                     |
|--------------------------|-----------------------------------------------------------------------------------|--------------------------|-----------------------------------------------------------------------------------|--------------------------|-----------------------------------------------------------------------------------|--------------------------|-----------------------------------------------------------------------------------|--------------------------|-------------------------------------------------------------------------------------|--------------------------|-------------------------------------------------------------------------------------|--------------------------|-------------------------------------------------------------------------------------|--------------------------|-------------------------------------------------------------------------------------|
| <input type="checkbox"/> |  | <input type="checkbox"/> |  | <input type="checkbox"/> |  | <input type="checkbox"/> |  | <input type="checkbox"/> |  | <input type="checkbox"/> |  | <input type="checkbox"/> |  | <input type="checkbox"/> |  |
|                          | Nr. 1                                                                             |                          | Nr. 6                                                                             |                          | Nr. 7                                                                             |                          | Nr. 8                                                                             |                          | Nr. 2                                                                               |                          | Nr. 4                                                                               |                          | Nr. 3                                                                               |                          | Nr. 5                                                                               |

- Lattes:
- |                          |           |                          |          |                          |          |                          |          |
|--------------------------|-----------|--------------------------|----------|--------------------------|----------|--------------------------|----------|
| <input type="checkbox"/> | 50/26 mm  | <input type="checkbox"/> | 60/26 mm | <input type="checkbox"/> | 70/26 mm | <input type="checkbox"/> | 80/26 mm |
| <input type="checkbox"/> | 100/26 mm | <input type="checkbox"/> | .....mm  |                          |          |                          |          |

Espace intermédiaire:  .....mm

autres Ø-bois  .....mm

Imprégnation:  brun  verdâtre  non imprégné

Remplissage de treillis:  treillis diagonal 50/50/2,5mm  treillis à noeud  sans treillis

Serrure:  clé numérique  avec section de cylindre Kaba  
 loquet de levage/verrou profilé  avec cylindre Kaba (plus-value)

Montants:

<input type="checkbox"/>	chêne 10/12 cm	<input type="checkbox"/>	acier en T 50/50/6 mm
<input type="checkbox"/>	chêne 12/12 cm	<input type="checkbox"/>	acier en T 60/60/7 mm
<input type="checkbox"/>	mélèze 10/10cm	<input type="checkbox"/>	acier en T 70/70/8 mm
<input type="checkbox"/>	montage au mur	<input type="checkbox"/>	pour acier en T du client
<input type="checkbox"/>	sans montants	<input type="checkbox"/>	pour acier en T existant
<input type="checkbox"/>	autres montants:		

Remarques: .....

.....

**Montage aux montants de bois:**

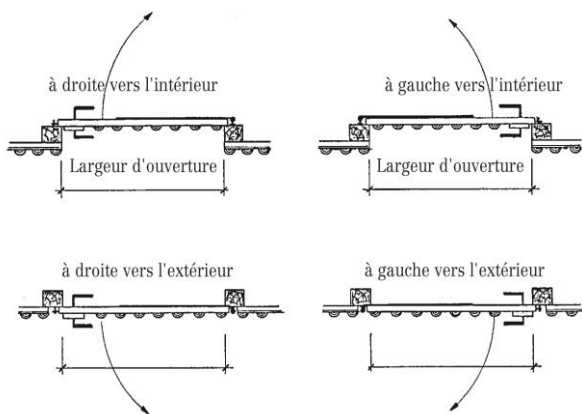

**Montage aux aciers en T:**

